

SPEED CONTROL MOTOR - SP SERIES

180W

□90mm

INDUCTION MOTOR

K9IS180F□-SP

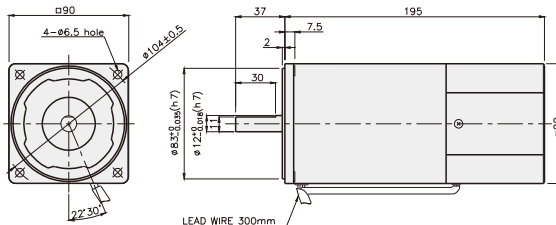
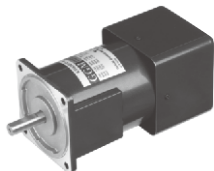

SPECIFICATIONS

180W 連続定格, 4極

Model	Voltage (V)	Frequency (Hz)	Speed Range (rpm)	Permissible Torque		Start T. (N*m/Kgf*cm)	Current (A)	Condenser (μF)
				1200rpm (N*m/Kgf*cm)	90rpm (N*m/Kgf*cm)			
K9I□180FJ-SP	100	50	90 ~ 1400	0.9/9	0.35/3.5	0.6/6	5.2	50
		60	90 ~ 1700			0.65/6.5	5.5	
K9I□180FU-SP	110	60	90 ~ 1700	0.9/9	0.35/3.5	0.52/5.2	4.8	35
	115					0.55/5.5	5	
K9I□180FL-SP	200	50	90 ~ 1400	0.9/9	0.3/3	0.5/5	2.2	12
		60	90 ~ 1700			0.42/4.2		
K9I□180FC-SP	220	50	90 ~ 1400	0.9/9	0.3/3	0.45/4.5	2.2	7
		60	90 ~ 1700			0.42/4.2	2	
	230	50	90 ~ 1400	1/10	0.33/3.3	0.53/5.3	2.4	
		60	90 ~ 1700			0.5/5	2.2	
K9I□180FD-SP	240	50	90 ~ 1400	1/10	0.33/3.3	0.6/6	2	8

* □ : SHAFT 形状 (S : STRAIGHT, P : PINION)

RATED TORQUE OF GEARHEAD

● 単相 100V/115V

単位 = 上段 : N·m / 下段 : kgf·cm

Model	Ratio	Speed (rpm)																								
		3	3.6	5	6	7.5	9	10	12.5	15	18	20	25	30	36	40	50	60	75	90	100	120	150	180	200	
K9I□180F□-SP K9P□BU, BUF	1200	2.19 21.9	2.62 26.2	3.65 36.5	4.37 43.7	5.47 54.7	6.56 65.6	7.29 72.9	8.20 82.0	9.84 98.4	11.81 118.1	13.12 131.2	14.76 147.6	17.71 177.1	21.26 212.6	23.62 236.2	29.52 295.2	30 300	30 300	30 300	30 300	30 300	30 300	30 300	30 300	30 300
	90	0.85 8.5	1.02 10.2	1.42 14.2	1.70 17.0	2.13 21.3	2.55 25.5	2.84 28.4	3.19 31.9	3.83 38.3	4.59 45.9	5.10 51.0	5.74 57.4	6.89 68.9	8.27 82.7	9.19 91.9	11.48 114.8	13.78 137.8	15.50 155.0	18.60 186.0	20.67 206.7	24.80 248.0	30 300	30 300	30 300	30 300

● 単相 200V/240V

単位 = 上段 : N·m / 下段 : kgf·cm

Model	Ratio	Speed (rpm)																								
		3	3.6	5	6	7.5	9	10	12.5	15	18	20	25	30	36	40	50	60	75	90	100	120	150	180	200	
K9I□180F□-SP K9P□BU, BUF	1200	200V/220V 50V/60Hz	2.19 21.9	2.62 26.2	3.65 36.5	4.37 43.7	5.47 54.7	6.56 65.6	7.29 72.9	8.20 82.0	9.84 98.4	11.81 118.1	13.12 131.2	14.76 147.6	17.71 177.1	21.26 212.6	23.62 236.2	29.52 295.2	30 300	30 300	30 300	30 300	30 300	30 300	30 300	30 300
		230V/50Hz/60Hz 240V/50Hz	2.43 24.3	2.92 29.2	4.05 40.5	4.86 48.6	6.08 60.8	7.29 72.9	8.10 81.0	9.11 91.1	10.94 109.4	13.12 132.2	14.58 145.8	16.40 164.0	19.68 197	23.62 236	26.24 262	30 300	30 300	30 300	30 300	30 300	30 300	30 300	30 300	30 300
	90	200V/220V 50Hz/60Hz	0.73 7.3	0.87 8.7	1.22 12.2	1.46 14.6	1.82 18.2	2.19 21.9	2.43 24.3	2.73 27.3	3.28 32.8	3.94 39.4	4.37 43.7	4.92 49.2	5.90 59.0	7.09 70.9	7.87 78.7	9.84 98.4	11.81 118.1	13.29 132.9	15.94 159.4	17.71 177.1	21.26 212.6	26.57 265.7	30 300	30 300
		230Hz/50Hz/60Hz 240V/50Hz	0.80 8.0	0.96 9.6	1.34 13.4	1.60 16.0	2.00 20.2	2.41 24.1	2.41 24.1	3.34 33.4	4.01 40.1	4.81 48.1	5.35 53.5	5.41 54.1	6.50 65.0	7.79 77.9	8.66 86.6	10.83 108.3	12.99 129.9	14.61 146.1	17.54 175.4	19.49 194.9	23.38 233.8	29.23 292.3	30 300	30 300

* GEARHEAD・DECIMAL GEARHEADは別売です。
 * GEARHEADの品名の中 □ には 減速比が入ります。
 * ■ 色がMOTORと同じ方向、その以外は反対方向です。
 * 表の減速比よりもっと減速しようとする場合には、ギアヘッドとモーターの間に減速比10のDECIMAL GEARHEADを設置することが可能です。この場合許容トルクは 30N·m/300kgf·cm です。
 * 回転数はMOTORの動機回転数(50Hz:1500rpm, 60Hz:1800rpm)を基準にして減速比に割って計算しました。実際に回転数は負荷の大きさによって表示される数値より2~20% 小さいです。

GEARHEADS

CONNECTION DIAGRAMS

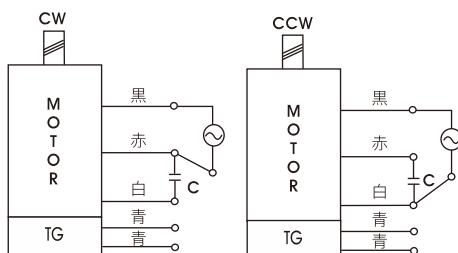

※ 回転方向は出力軸から見た場合

DIMENSIONS

K9P□BU

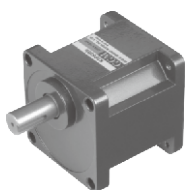

K9P□BUF

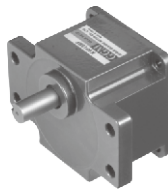

DECIMAL GEARHEAD

K9P10BX

KEY SPEC

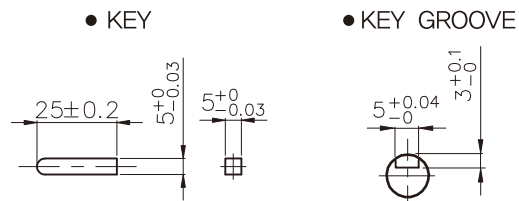
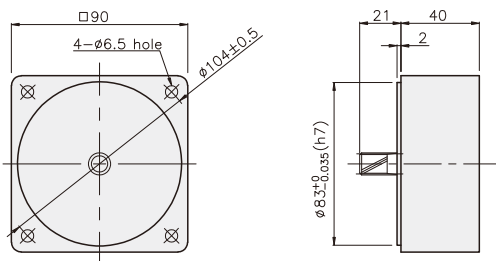

GEARHEAD

K9P□BU

K9P□BUF

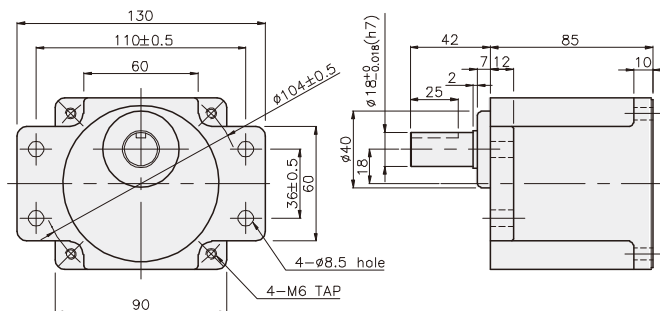
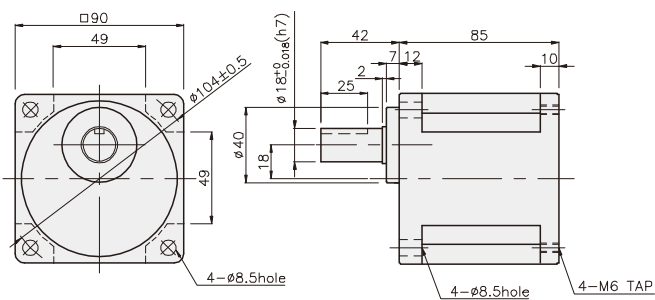

GEARHEADS

DIMENSIONS

K9IP180F□-SP + K9P□BU

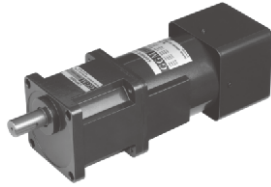

K9IP180F□-SP + K9P□BUF

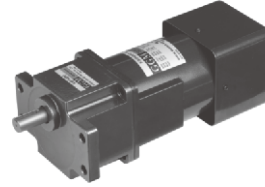

重さ

PART	WEIGHT(kg)
MOTOR	4,24
DECIMAL GEAR HEAD	0,62

寸法図表

品番	適用機種	取付BOLT
01	K9P3~200B	M6 P1,0 X 20
02	K9P10BX	M6 P1,0 X 65

重さ

PART	WEIGHT(kg)
K9P3~10BU	1,44
K9P12,5~20BU	1,55
K9P25~60BU	1,69
K9P75~200BU	1,74

寸法図表

品番	適用機種	取付BOLT
01	K9P3~200BUF	M6 P1,0 X 20
02	K9P10BX	M6 P1,0 X 65

重さ

PART	WEIGHT(kg)
K9P3~10BUF	1,50
K9P12,5~20BUF	1,62
K9P25~60BUF	1,76
K9P75~200BUF	1,82

K9IP180F□-SP + K9P□BU

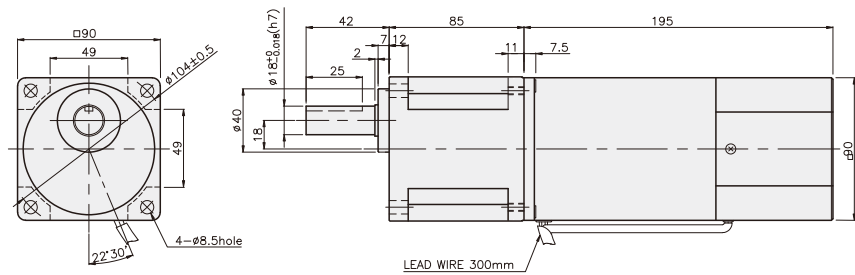

K9IP180F□-SP + K9P□BUF

