

SPEED CONTROL & BRAKE MOTOR

60W

□90mm

K9RS60F□-D

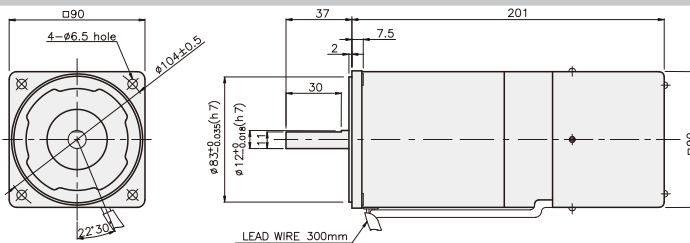

SPECIFICATIONS

60W 30分 定格, 4極

Model	Voltage (V)	Frequency (Hz)	Speed Range (rpm)	Permissible Torque		Start T. (N*m/Kgf*cm)	Current (A)	Condenser (μF)	Friction T. (N*m/Kgf*cm)
				1200rpm (N*m/Kgf*cm)	90rpm (N*m/Kgf*cm)				
K9R□60FJ-D	100	50	90 ~ 1400	0.5/5	0.17/1.7	0.3/3	2.5	25	1/10
			90 ~ 1700						
K9R□60FU-D	110	60	90 ~ 1700	0.5/5	0.17/1.7	0.295/2.95	2.1	17	1/10
	115						2.2		
K9R□60FL-D	200	50	90 ~ 1400	0.5/5	0.15/1.5	0.26/2.6	0.72	6	1/10
			90 ~ 1700						
K9R□60FC-D	220	50	90 ~ 1400	0.5/5	0.15/1.5	0.3/3	0.95	5	1/10
			90 ~ 1700						
		50	90 ~ 1400	0.5/5	0.15/1.5	0.3/3	1		
			90 ~ 1700						
K9R□60FD-D	240	50	90 ~ 1400	0.5/5	0.15/1.5	0.32/3.2	1.2	5	1/10

* □ : SHAFT 形状 (S : STRAIGHT, P : PINION)

RATED TORQUE OF GEARHEAD

● 単相 100V/115V

単位 = 上段 : N·m / 下段 : kgf·cm

Model	Ratio	Speed (rpm)																							
		3	3.6	5	6	7.5	9	10	12.5	15	18	20	25	30	36	40	50	60	75	90	100	120	150	180	200
K9R□60F□-D K9P□B, BF	1200	1.22 1.22	1.46 1.46	2.03 20.3	2.43 24.3	3.04 30.4	3.65 36.5	4.05 40.5	4.56 45.6	5.47 54.7	6.56 65.6	7.29 72.9	8.20 82.0	9.84 98.4	11.81 118.1	13.12 131.2	16.40 164.0	19.68 196.8	20 200	20 200	20 200	20 200	20 200	20 200	20 200
	90	0.41 4.1	0.50 5.0	0.69 6.9	0.83 8.3	1.03 10.3	1.24 12.4	1.38 13.8	1.55 15.5	1.86 18.6	2.23 22.3	2.48 24.8	2.79 27.9	3.35 33.5	4.02 40.2	4.46 44.6	5.58 55.8	6.69 66.9	7.53 75.3	9.03 90.3	10.04 100.4	12.05 120.5	15.06 150.6	18.07 180.7	20 200

● 単相 200V/240V

単位 = 上段 : N·m / 下段 : kgf·cm

Model	Ratio	Speed (rpm)																								
		3	3.6	5	6	7.5	9	10	12.5	15	18	20	25	30	36	40	50	60	75	90	100	120	150	180	200	
K9R□60F□-D K9P□B, BF	1200	200V/220V/230V/240V/50Hz	1.22 12.2	1.46 14.6	2.03 20.3	2.43 24.3	3.04 30.4	3.65 36.5	4.05 40.5	4.56 45.6	5.47 54.7	6.56 65.6	7.29 72.9	8.20 82.0	9.84 98.4	11.81 118.1	13.12 131.2	16.40 164.0	19.68 196.8	20 200	20 200	20 200	20 200	20 200	20 200	20 200
		200V/220V/230V/60Hz	1.17 11.7	1.40 14.0	1.94 19.4	2.33 23.3	2.92 29.2	3.50 35.0	3.89 38.9	4.37 43.7	5.25 52.5	6.30 63.0	7.00 70.0	7.87 78.7	9.45 94.5	11.34 113.4	12.60 126.0	15.75 157.5	18.90 189.0	20 200	20 200	20 200	20 200	20 200	20 200	20 200
	90	200V/220V/230V/240V/50Hz	0.36 3.6	0.44 4.4	0.61 6.1	0.73 7.3	0.91 9.1	1.09 10.9	1.22 12.2	1.37 13.7	1.64 16.4	1.97 19.7	2.19 21.9	2.46 24.6	2.95 29.5	3.54 35.4	3.94 39.4	4.92 49.2	5.90 59.0	6.64 66.4	7.97 79.7	8.86 88.6	10.63 106.3	13.29 132.9	15.94 159.4	17.71 177.1
		200V/220V/230V/60Hz	0.41 4.1	0.50 5.0	0.69 6.9	0.83 8.3	1.03 10.3	1.24 12.4	1.38 13.8	1.55 15.5	1.86 18.6	2.23 22.3	2.48 24.8	2.79 27.9	3.35 33.5	4.02 40.2	4.46 44.6	5.58 55.8	6.69 66.9	7.53 75.3	9.03 90.3	10.04 100.4	12.05 120.5	15.06 150.6	18.07 180.7	20 200

- * GEARHEAD・DECIMAL GEARHEADは別売です。
- * GEARHEADの品名の中 □ には 減速比が入ります。
- * 色がMOTORと同じ方向、その以外は反対方向です。
- * 表の減速比よりもっと減速しようとする場合には、ギアヘッドとモーターの間に減速比10のDECIMAL GEARHEADを設置することが可能です。この場合許容トルクは 20N・m/200kgfcm です。
- * 回転数はMOTORの動機回転数(50Hz:1500rpm, 60Hz:1800rpm)を基準にして減速比に割って計算しました。実際を回転数は負荷の大きさによって表示される数値より 2~20% 小さいです。

GEARHEADS

CONNECTION DIAGRAMS

接点保護のために結線図のようにサージ(Surge)電圧吸収用Cr回路を接続してください。
 $R_o = 5 - 200\Omega$
 $C_o = 0.1 \sim 0.2\mu F \ 200WV(400WV)$

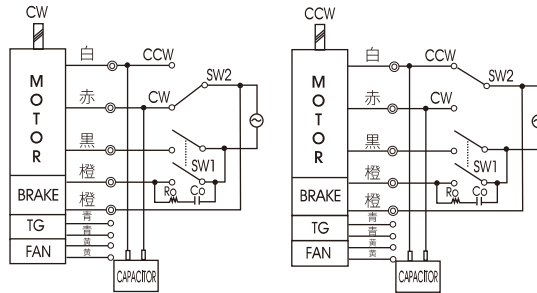

※回転方向は出力軸から見た場合

DIMENSIONS

K9P□B



K9P□BF



DECIMAL GEARHEAD

K9P10BX

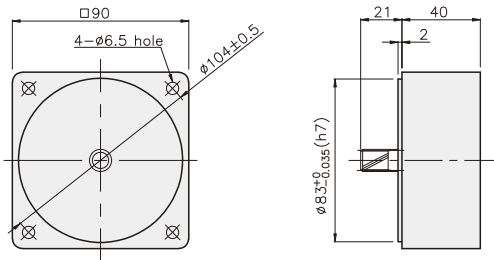

KEY SPEC

● KEY

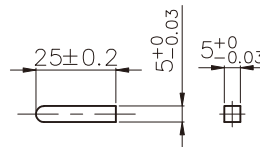

● KEY GROOVE

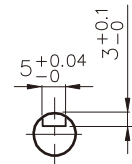

GEARHEAD

K9P□B

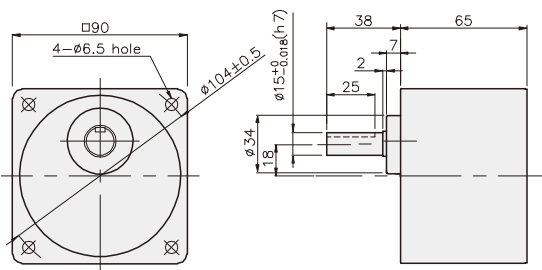

K9P□BF

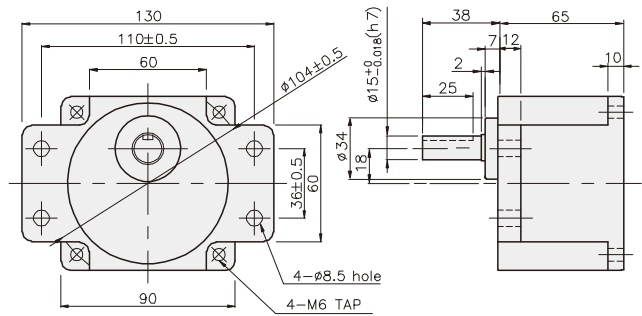

GEARHEADS

DIMENSIONS

K9RP60F□-D + K9P□B



K9RP60F□-D + K9P□BF



K9RP60F□-D + K9P□B

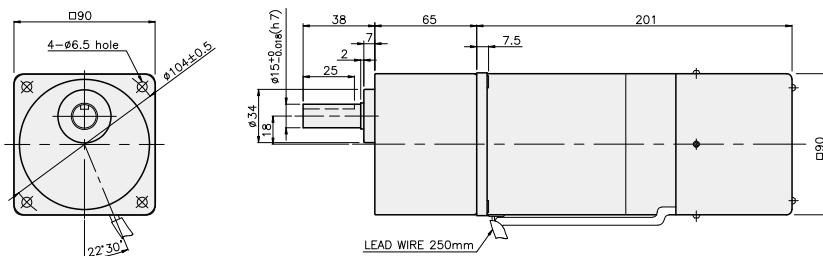

寸法図表

品番	適用機種	取付BOLT
01	K9P3~200B	M6 P1.0 X 95
02	K9P10BX	M6 P1.0 X 140

重さ

PART	WEIGHT(kg)	
MOTOR	3.58	
DECIMAL GEAR HEAD	0.62	
GEAR HEAD	K9P3~10B	1.22
	K9P12.5~20B	1.32
	K9P25~60B	1.42
	K9P75~200B	1.45

K9RP60F□-D + K9P□BF

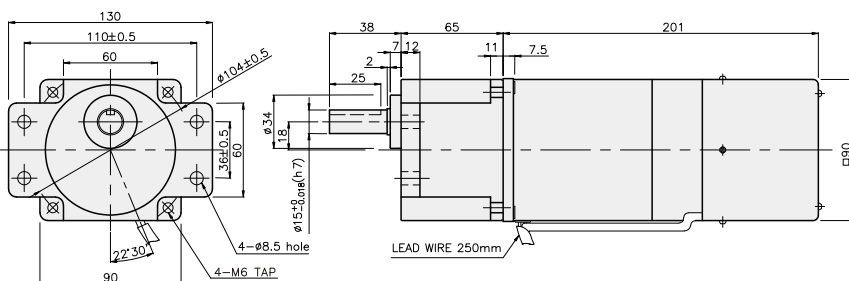

寸法図表

品番	適用機種	取付BOLT
01	K9P3~200BF	M6 P1.0 X 20
02	K9P10BX	M6 P1.0 X 65

重さ

PART	WEIGHT(kg)	
MOTOR	3.58	
DECIMAL GEAR HEAD	0.62	
GEAR HEAD	K9P3~10BF	1.22
	K9P12.5~18BF	1.30
	K9P20~60BF	1.42
	K9P75~200BF	1.44