

BRAKE MOTOR

120W

□90mm

K9 □S120F□-B

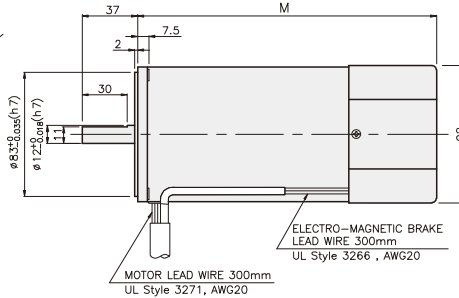
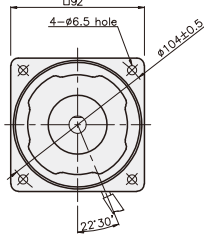

치수도표

모델	M	적용기종
K9RS120F□-B-C50	200	50Hz
K9RS120F□-B	179	60Hz

※ 50Hz 제품은 모델명예 C50이 표기됩니다.

SPECIFICATIONS

120W 30분 정격, 4극

Model	Duty	Voltage (V)	Frequency (Hz)	Current (A)	Start T. (N·m/kgf·cm)	Rated T. (N·m/kgf·cm)	Speed (rpm)	Condenser (μF)	Friction T. (N·m/kgf·cm)
K9R□120FJ-B-C50	단상 30분	100	50	2.4	0.65/6.5	0.9/9	1300	40	1/10
K9R□120FJ-B			60	2.61	0.7/7	0.755/7.55	1550		
K9R□120FU-B		110	60	1.93	0.6/6	0.755/7.55	1550	25	1/10
				1.88	0.62/6.2				
K9R□120FL-B-C50		200	50	1.07	0.6/6	0.9/9	1300	8.5	1/10
K9R□120FL-B				60	1.22	0.58/5.8	0.755/7.55	1550	
K9R□120FC-B-C50		220	50	0.82	0.53/5.3	0.9/9	1300	6	1/10
				0.85	0.58/5.8				
K9R□120FC-B		220	60	1	0.63/6.3	0.735/7.35	1600	7	1/10
				1.1					
K9R□120FD-B-C50		240	50	0.9	0.58/5.8	0.9/9	1300	6	1/10

* □ : SHAFT 형상(S : STRAIGHT, P : PINION)

RATED TORQUE OF GEARHEAD

● 50Hz

단위 = 상단 : N·m / 하단 : kgf·cm

Model	Speed(rpm)	500	416	300	250	200	166	150	120	100	83	75	60	50	41	37	30	25	20	16	15	13	10	8.3	7.5
Motor/ Gearhead	Ratio	3	3.6	5	6	7.5	9	10	12.5	15	18	20	25	30	36	40	50	60	75	90	100	120	150	180	200
K9RP120F□-B K9P□B, BF		2.19	2.62	3.65	4.37	5.47	6.56	7.29	8.20	9.84	11.81	13.12	14.76	17.71	20	20	20	20	20	20	20	20	20	20	20
		21.9	26.2	36.5	43.7	54.7	65.6	72.9	82.0	98.4	118.1	131.2	147.6	177.1	200	200	200	200	200	200	200	200	200	200	200

● 60Hz

단위 = 상단 : N·m / 하단 : kgf·cm

Model	Speed(rpm)	600	500	360	300	240	200	180	144	120	100	90	72	60	50	45	36	30	24	20	18	15	12	10	9
Motor/ Gearhead	Ratio	3	3.6	5	6	7.5	9	10	12.5	15	18	20	25	30	36	40	50	60	75	90	100	120	150	180	200
K9RP120F□-B K9P□B, BF		1.79	2.14	2.98	3.57	4.47	5.36	5.95	6.70	8.04	9.64	10.72	12.06	14.47	17.36	19.29	20	20	20	20	20	20	20	20	20
		17.9	21.4	29.8	35.7	44.7	53.6	59.5	67.0	80.4	96.4	107.2	120.6	144.7	173.6	192.9	200	200	200	200	200	200	200	200	200

- * GEARHEAD-DECIMAL GEARHEAD는 별매입니다.
- * GEARHEAD의 품명중 □에는 감속비가 들어갑니다.
- * 색이 MOTOR와 같은 방향, 그 외에는 반대 방향입니다.
- * 표의 감속비보다 더 감속하고자 할 경우는 GEARHEAD와 MOTOR 사이에 감속비 10의 DECIMAL GEARHEAD를 설치할 수 있습니다. 이 경우의 허용 TORQUE는 20 N·m / 200 kgf·cm 입니다.
- * 회전수는 MOTOR의 동기 회전수 (50 Hz : 1500 rpm, 60 Hz : 1800 rpm)를 기준으로 하여 감속비로 나누어서 계산하였습니다. 실제의 회전수는 부하의 크기에 따라서 표시된 수치보다 2~20% 적습니다.

GEARHEAD

RATED TORQUE OF GEARHEAD

● 50Hz

단위 = 상단 : N·m / 하단 : kgf·cm

Model	Speed(rpm)	500	416	300	250	200	166	150	120	100	83	75	60	50	41	37	30	25	20	16	15	13	10	8,3	7,5
Motor/ Gearhead	Ratio	3	3,6	5	6	7,5	9	10	12,5	15	18	20	25	30	36	40	50	60	75	90	100	120	150	180	200
K9RP120F□-B		2,19	2,62	3,65	4,37	5,47	6,56	7,29	8,20	9,84	11,81	13,12	14,76	17,71	21,26	23,62	30	30	30	30	30	30	30	30	30
K9P□BU, BUF		21,9	26,2	36,5	43,7	54,7	65,6	72,9	82,0	98,4	118,1	131,2	147,6	177,1	212,6	236,2	300	300	300	300	300	300	300	300	300

● 60Hz

단위 = 상단 : N·m / 하단 : kgf·cm

Model	Speed(rpm)	600	500	360	300	240	200	180	144	120	100	90	72	60	50	45	36	30	24	20	18	15	12	10	9
Motor/ Gearhead	Ratio	3	3,6	5	6	7,5	9	10	12,5	15	18	20	25	30	36	40	50	60	75	90	100	120	150	180	200
K9RP120F□-B		1,79	2,14	2,98	3,57	4,47	5,36	5,95	6,70	8,04	9,64	10,72	12,06	14,47	17,36	19,29	24,11	28,93	30	30	30	30	30	30	30
K9P□BU, BUF		17,9	21,4	29,8	35,7	44,7	53,6	59,5	67,0	80,4	96,4	107,2	120,6	144,7	173,6	192,9	241,1	289,3	300	300	300	300	300	300	300

- * GEARHEAD·DECIMAL GEARHEAD는 별매입니다.
- * GEARHEAD의 품명중 □에는 감속비가 들어갑니다.
- * 색이 MOTOR와 같은 방향, 그 외에는 반대 방향입니다.
- * 표의 감속비보다 더 감속하고자 할 경우는 GEARHEAD와 MOTOR 사이에 감속비 10의 DECIMAL GEARHEAD를 설치할 수 있습니다. 이 경우의 허용 TORQUE는 30 N·m / 300 kgf·cm 입니다.
- * 회전수는 MOTOR의 동기 회전수 (50 Hz : 1500 rpm, 60 Hz : 1800 rpm)를 기준으로 하여 감속비로 나누어서 계산하였습니다. 실제의 회전수는 부하의 크기에 따라서 표시된 수치보다 2~20% 적습니다.

CONNECTION DIAGRAMS

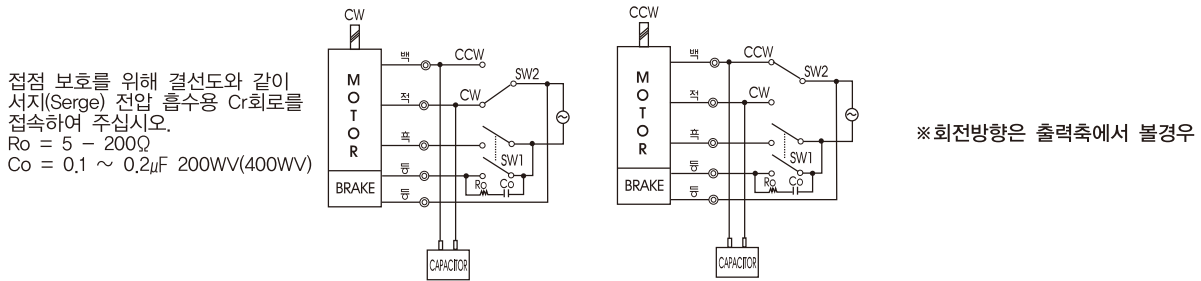

GEARHEAD

DIMENSIONS

K9P□B



K9P□BF, BUF

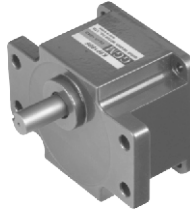

K9P□BU

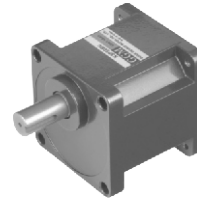

DECIMAL GEARHEAD

K9P10BX

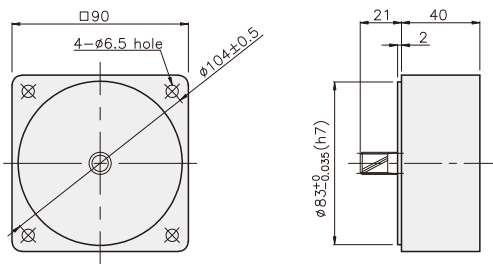

KEY SPEC

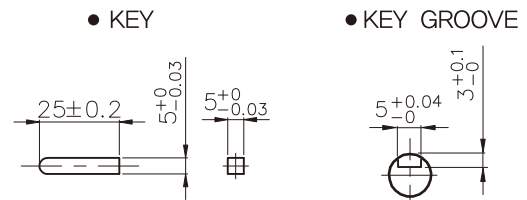

GEARHEAD

K9P□B

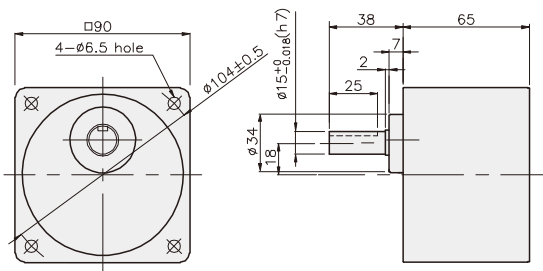

K9P□BF

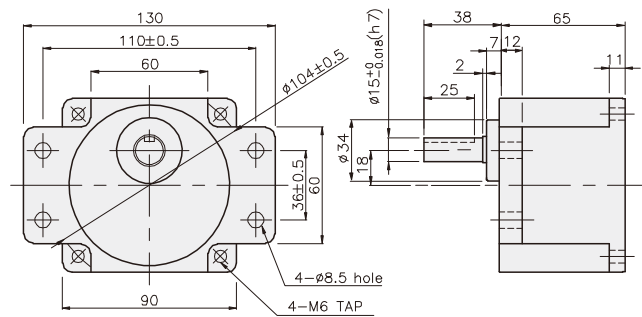

K9P□BU

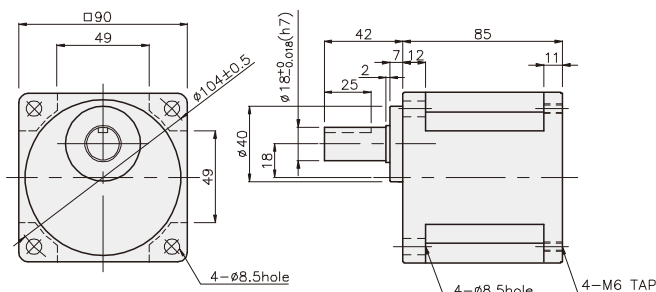

K9P□BUF

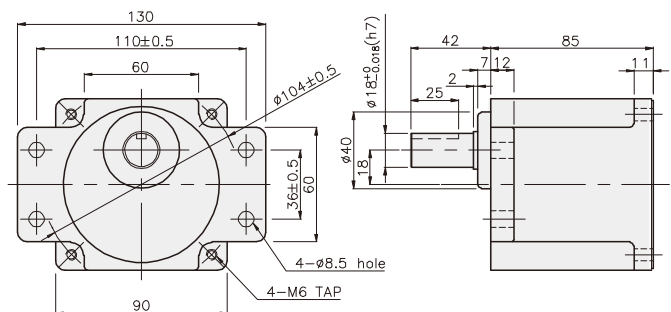

GEARHEAD

DIMENSIONS

K9RP120F□-B + K9P□B



K9RP120F□-B + K9P□BF, BUF



K9RP120F□-B + K9P□BU



K9RP120F□-B + K9P□B

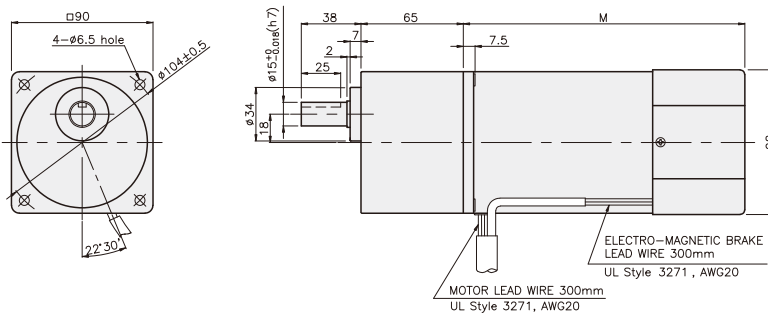

K9RP120F□-B + K9P□BF

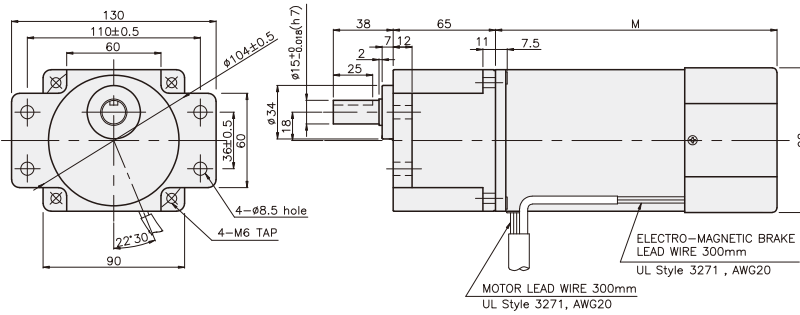

K9RP120F□-B + K9P□BU

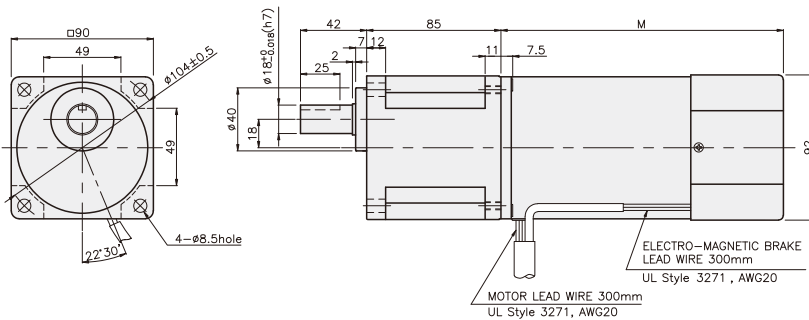

K9RP120F□-B + K9P□BUF

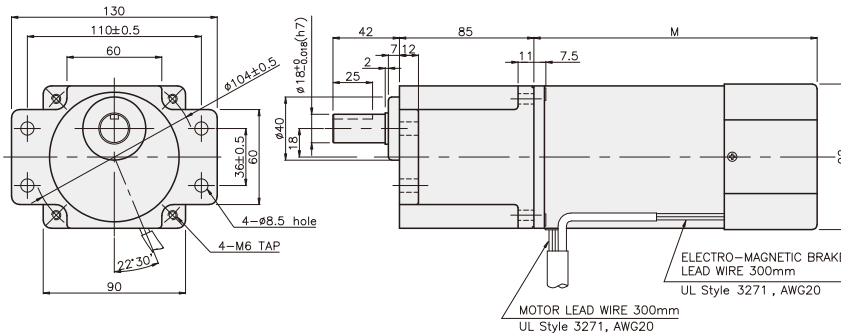

무게

PART	WEIGHT(kg)
MOTOR	3.20
DECIMAL GEARHEAD	0.62

치수도표

품번	M	적용기종
01	200	50Hz
02	179	60Hz

치수도표

품번	적용기종	취부 BOLT
01	K9P3~200B	M6 P1.0 X 95
02	K9P10BX	M6 P1.0 X 140

무게

PART	WEIGHT(kg)
K9P3~10B	1.22
K9P12.5~20B	1.32
K9P25~60B	1.42
K9P75~200B	1.45

치수도표

품번	적용기종	취부 BOLT
01	K9P3~200BF	M6 P1.0 X 20
02	K9P10BX	M6 P1.0 X 65

무게

PART	WEIGHT(kg)
K9P3~10BF	1.22
K9P12.5~20BF	1.30
K9P25~60BF	1.42
K9P75~200BF	1.44

치수도표

품번	적용기종	취부 BOLT
01	K9P3~200BU	M6 P1.0 X 20
02	K9P10BX	M6 P1.0 X 65

무게

PART	WEIGHT(kg)
K9P3~10BU	1.44
K9P12.5~20BU	1.55
K9P25~60BU	1.69
K9P75~200BU	1.74

치수도표

품번	적용기종	취부 BOLT
01	K9P3~200BUF	M6 P1.0 X 20
02	K9P10BX	M6 P1.0 X 65

무게

PART	WEIGHT(kg)
K9P3~10BUF	1.50
K9P12.5~20BUF	1.62
K9P25~60BUF	1.76
K9P75~200BUF	1.82