

SPEED CONTROL MOTOR - SU SERIES

60W

□90mm

REVERSIBLE MOTOR

K9RS60F□-SU

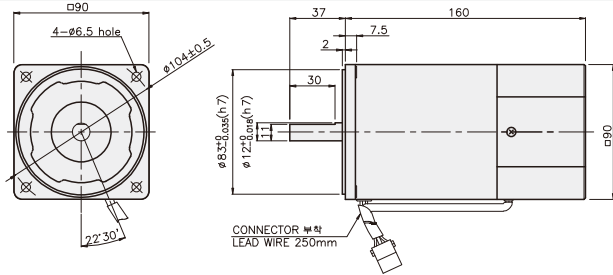
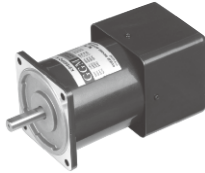

SPECIFICATIONS

60W 30분 정격, 4극

Model	Voltage (V)	Frequency (Hz)	Speed (rpm)	Permissible Torque		Start T. (N·m/kgf·cm)	Current (A)	Condenser (μF)
				1200rpm	90rpm			
				(N·m/kgf·cm)	(N·m/kgf·cm)			
K9R□60FJ-SU	100	50	90 ~ 1400	0.5/5	0.17/1.7	0.3/3	2.5	25
			90 ~ 1700					
K9R□60FU-SU	110	60	90 ~ 1700	0.5/5	0.17/1.7	0.295/2.95	2.1	17
	115							
K9R□60FL-SU	200	50	90 ~ 1400	0.5/5	0.15/1.5	0.26/2.6	0.72	6
		60	90 ~ 1700	0.48/4.8	0.17/1.7	0.23/2.3	0.76	
K9R□60FC-SU	220	50	90 ~ 1400	0.5/5	0.15/1.5	0.3/3	0.95	5
		60	90 ~ 1700	0.48/4.8	0.17/1.7	0.26/2.6	0.94	
	230	50	90 ~ 1400	0.5/5	0.15/1.5	0.3	1	
		60	90 ~ 1700	0.48/4.8	0.17/1.7	0.26/2.6	1.2	
K9R□60FD-SU	240	50	90 ~ 1400	0.5/5	0.15/1.5	0.32/3.2	1.2	

※ □ : SHAFT 형상 (S : STRAIGHT, P : PINION)

RATED TORQUE OF GEARHEAD

● 단상 100V/115V

단위 = 상단 : N·m / 하단 : kgf·cm

Model	Ratio	Speed(rpm)																								
		3	36	5	6	7.5	9	10	12.5	15	18	20	25	30	36	40	50	60	75	90	100	120	150	180	200	
K9R□60F□-SU K9P□B, BF	1200	1.22	1.46	2.03	2.43	3.04	3.65	4.05	4.56	5.47	6.56	7.29	8.20	9.84	11.81	13.12	16.40	19.68	20	20	20	20	20	20	20	20
	90	0.41	0.50	0.69	0.83	1.03	1.24	1.38	1.55	1.86	2.23	2.48	2.79	3.35	4.02	4.46	5.58	6.69	7.53	9.03	10.04	12.05	15.06	18.07	20	

● 단상 200V/240V

단위 = 상단 : N·m / 하단 : kgf·cm

Model	Ratio	Speed(rpm)																								
		3	36	5	6	7.5	9	10	12.5	15	18	20	25	30	36	40	50	60	75	90	100	120	150	180	200	
K9R□60F□-SU K9P□B, BF	1200	200V/220V	1.22	1.46	2.03	2.43	3.04	3.65	4.05	4.56	5.47	6.56	7.29	8.20	9.84	11.81	13.12	16.40	19.68	20	20	20	20	20	20	20
		230V/240V	1.22	1.46	2.03	2.43	3.04	3.65	4.05	4.56	5.47	6.56	7.29	8.20	9.84	11.81	13.12	16.40	19.68	200	200	200	200	200	200	200
	90	200V/220V	1.17	1.40	1.94	2.33	2.92	3.50	3.89	4.37	5.25	6.30	7.00	7.87	9.45	11.34	12.60	15.75	18.90	20	20	20	20	20	20	20
		230V/240V	1.17	1.40	1.94	2.33	2.92	3.50	3.89	4.37	5.25	6.30	7.00	7.87	9.45	11.34	12.60	15.75	18.90	200	200	200	200	200	200	200
	90	200V/220V	0.36	0.44	0.61	0.73	0.91	1.09	1.22	1.37	1.64	1.97	2.19	2.46	2.95	3.54	3.94	4.92	5.90	6.64	7.97	8.86	10.63	13.29	15.94	17.71
		230V/240V	0.36	0.44	0.61	0.73	0.91	1.09	1.22	1.37	1.64	1.97	2.19	2.46	2.95	3.54	3.94	4.92	5.90	6.64	7.97	8.86	10.63	13.29	15.94	17.71

- * GEARHEAD·DECIMAL GEARHEAD는 별매입니다.
- * GEARHEAD의 품명중 □에는 감속비가 들어갑니다.
- * 색이 MOTOR와 같은 방향, 그 외에는 반대 방향입니다.
- * 표의 감속비보다 더 감속하고자 할 경우는 GEARHEAD와 MOTOR 사이에 감속비 10의 DECIMAL GEARHEAD를 설치할 수 있습니다. 이 경우의 허용 TORQUE는 20 N·m / 200 kgf·cm 입니다.
- * 회전수는 MOTOR의 동기 회전수 (50 Hz : 1500 rpm, 60 Hz : 1800 rpm)를 기준으로 하여 감속비로 나누어서 계산하였습니다. 실제의 회전수는 부하의 크기에 따라서 표시된 수치보다 2~20% 적습니다.

GEARHEAD

CONNECTION DIAGRAMS

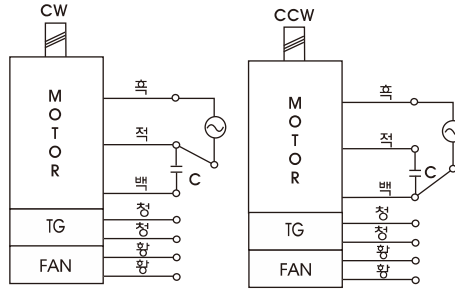

회전방향은 출력축에서 볼 경우

DIMENSIONS

K9P□B



K9P□BF

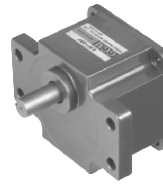

DECIMAL GEARHEAD

K9P10BX

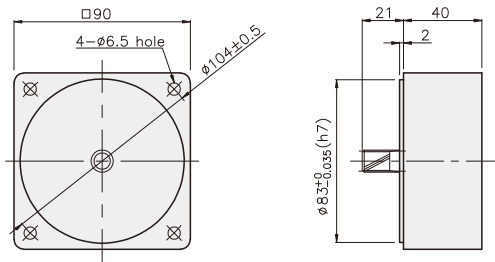

KEY SPEC

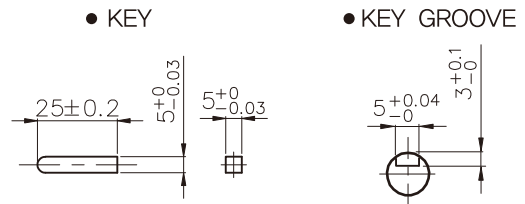

GEARHEAD

K9P□B

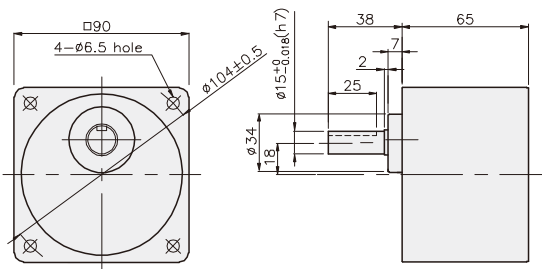

K9P□BF

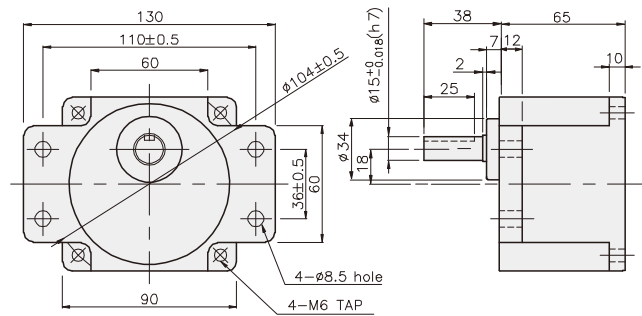

SPEED CONTROL MOTOR
- SU SERIES

GEARHEAD

DIMENSIONS

K9RP60F□-SU + K9P□B

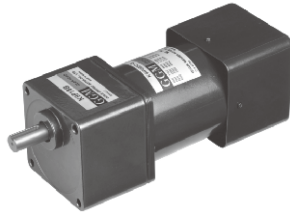

K9RP60F□-SU + K9P□BF

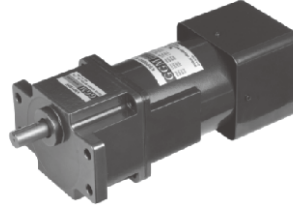

K9RP60F□-SU + K9P□B

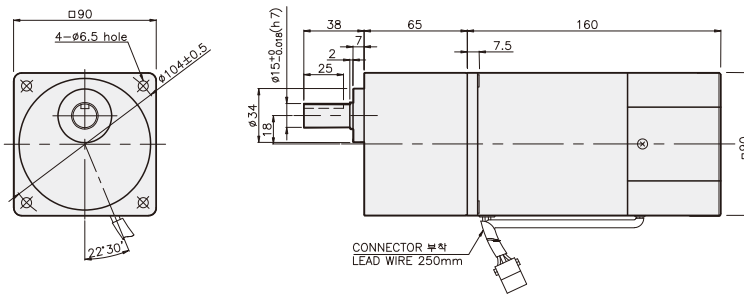

치수도표

품번	적용기종	취부 BOLT
01	K9P3~200B	M6 P1.0 × 95
02	K9P10BX	M6 P1.0 × 140

무게

PART		WEIGHT(kg)
MOTOR		3.06
DECIMAL GEARHEAD		0.62
GEAR HEAD	K9P3~10B	1.22
	K9P12.5~20B	1.32
	K9P25~60B	1.42
	K9P75~200B	1.45

K9RP60F□-SU + K9P□BF

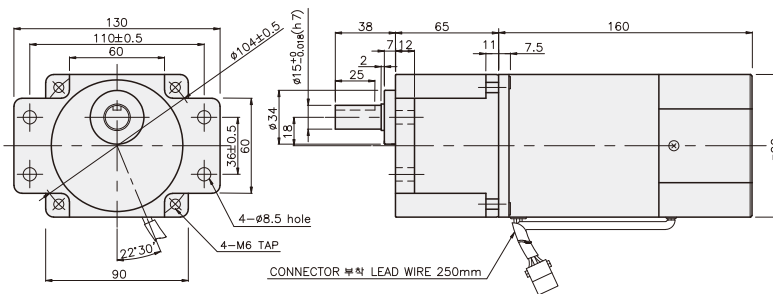

치수도표

품번	적용기종	취부 BOLT
01	K9P3~200BF	M6 P1.0 × 20
02	K9P10BX	M6 P1.0 × 65

무게

PART		WEIGHT(kg)
MOTOR		3.58
DECIMAL GEARHEAD		0.62
GEAR HEAD	K9P3~10BF	1.22
	K9P12.5~20BF	1.30
	K9P25~60BF	1.42
	K9P75~200BF	1.44