

## SPEED CONTROL MOTOR - SU SERIES

### 120W

### □90mm INDUCTION MOTOR

K9IS120F□-SU

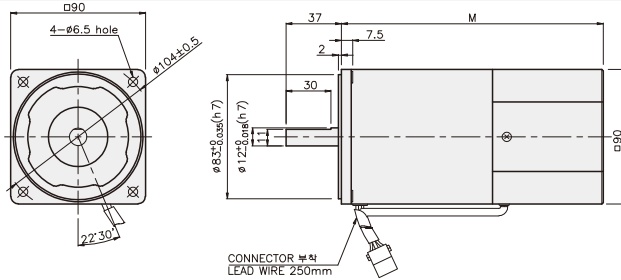
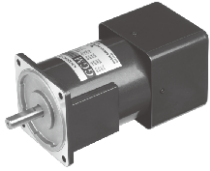

치수도표

모델	M	적용기종
K9IS120F□-SU-C50	195	50Hz
K9IS120F□-SU	175	60Hz

※ 50Hz 제품은 모델명에 C50이 표기됩니다.

### SPECIFICATIONS

120W 연속정격, 4극

Model	Voltage (V)	Frequency (Hz)	Speed (rpm)	Permissible Torque		Start T. (N·m/kgf·cm)	Current (A)	Condenser (μF)
				1200 rpm (N·m/kgf·cm)	90 rpm (N·m/kgf·cm)			
K9I□120FJ-SU-C50	100	50	90 ~ 1400	0.83/8.3	0.3/3	0.4/4	3.4	35
K9I□120FJ-SU		60	90 ~ 1700			0.45/4.5		
K9I□120FU-SU	110	60	90 ~ 1700	0.83/8.3	0.3/3	0.45/4.5	3.2	30
	115							
K9I□120FL-SU-C50	200	50	90 ~ 1400	0.83/8.3	0.28/2.8	0.4/4	1.4	8.5
K9I□120FL-SU		60	90 ~ 1700	0.8/8	0.3/3	1.5	8	
K9I□120FC-SU-C50	220	50	90 ~ 1400	0.83/8.3	0.28/2.8	0.4/4	1.2	6
			90 ~ 1700					
K9I□120FC-SU	220	60	90 ~ 1400	0.8/8	0.3/3	0.45/4.5	1.4	7
			90 ~ 1700					
K9I□120FD-SU-C50	240	50	90 ~ 1400	0.83/8.3	0.28/2.8	0.4/4	1.3	6

\* □ : SHAFT 형상(S : STAIRAIGHT, P : PINION)

### RATED TORQUE OF GEARHEAD

#### ● 단상 100V/115V

단위 = 상단 : N·m / 하단 : kgf·cm

Model	Ratio	3	3.6	5	6	7.5	9	10	12.5	15	18	20	25	30	36	40	50	60	75	90	100	120	150	180	200	
K9I□120F□-SU K9P□B, BF	1200	2.02 20.2	2.42 24.2	3.36 33.6	4.03 40.3	5.04 50.4	6.05 60.5	6.72 67.2	7.56 75.6	9.08 90.8	10.89 108.9	12.10 121.0	13.61 136.1	16.34 163.4	19.60 196.0	20	20	20	20	20	20	20	20	20	20	20
	90	0.73 7.3	0.87 8.7	1.22 12.2	1.46 14.6	1.82 18.2	2.19 21.9	2.43 24.3	2.73 27.3	3.28 32.8	3.94 39.4	4.37 43.7	4.92 49.2	5.90 59.0	7.09 70.9	7.87 78.7	9.84 98.4	11.81 118.1	13.29 132.9	15.94 159.4	17.71 177.1	20	20	20	20	20

#### ● 단상 200V/240V

단위 = 상단 : N·m / 하단 : kgf·cm

Model	Ratio	3	3.6	5	6	7.5	9	10	12.5	15	18	20	25	30	36	40	50	60	75	90	100	120	150	180	200		
K9I□120F□-SU K9P□B, BF	1200	200V/220V/230V 240V/50Hz	2.02 20.2	2.42 24.2	3.36 33.6	4.03 40.3	5.04 50.4	6.05 60.5	6.72 67.2	7.56 75.6	9.08 90.8	10.89 108.9	12.10 121.0	13.61 136.1	16.34 163.4	19.60 196.0	20	20	20	20	20	20	20	20	20	20	
		200V/220V 230V/60Hz	1.94 19.4	2.33 23.3	3.24 32.4	3.89 38.9	4.86 48.6	5.83 58.3	6.48 64.8	7.29 72.9	8.75 87.5	10.50 105.0	11.66 116.6	13.12 131.2	15.75 157.5	18.90 189.0	20	20	20	20	20	20	20	20	20	20	
	90	200V/220V/230V 240V/50Hz	0.68 6.8	0.82 8.2	1.13 11.3	1.36 13.6	1.70 17.0	2.04 20.4	2.27 22.7	2.55 25.5	3.06 30.6	3.67 36.7	4.08 40.8	4.59 45.9	5.51 55.1	6.61 66.1	7.35 73.5	9.19 91.9	11.02 110.2	12.40 124.0	14.88 148.8	16.53 165.3	19.84 198.4	20	20	20	20
		200V/220V 230V/60Hz	0.73 7.3	0.87 8.7	1.22 12.2	1.46 14.6	1.82 18.2	2.19 21.9	2.43 24.3	2.73 27.3	3.28 32.8	3.94 39.4	4.37 43.7	4.92 49.2	5.90 59.0	7.09 70.9	7.87 78.7	9.84 98.4	11.81 118.1	13.29 132.9	15.94 159.4	17.71 177.1	20	20	20	20	20

- \* GEARHEAD-DECIMAL GEARHEAD는 별매입니다.
- \* GEARHEAD의 품명중 □에는 감속비가 들어갑니다.
- \* ■ 색이 MOTOR와 같은 방향, 그 외에는 반대 방향입니다.
- \* 표의 감속비보다 더 감속하고자 할 경우는 GEARHEAD와 MOTOR 사이에 감속비 10의 DECIMAL GEARHEAD를 설치할 수 있습니다. 이 경우의 허용 TORQUE는 20 N·m / 200 kgf·cm 입니다.
- \* 회전수는 MOTOR의 동기 회전수 (50 Hz : 1500 rpm, 60 Hz : 1800 rpm)를 기준으로 하여 감속비로 나누어서 계산하였습니다. 실제의 회전수는 부하의 크기에 따라서 표시된 수치보다 2~20% 적습니다.

SPEED CONTROL MOTOR - SU SERIES

## GEARHEAD

### RATED TORQUE OF GEARHEAD

#### ● 단상 100V/115V

단위 = 상단 : N·m / 하단 : kgf·cm

Model Motor/Gearhead	Ratio Speed(rpm)	3	3,6	5	6	7,5	9	10	12,5	15	18	20	25	30	36	40	50	60	75	90	100	120	150	180	200
		K9I□120F□-SU K9P□BU, BUF	1200	2.02 20,2	2.42 24,2	3.36 33,6	4.03 40,3	5.04 50,4	6.05 60,5	6.72 67,2	7.56 75,6	9.08 90,8	10.89 108,9	12.10 121,0	13.61 136,1	16.34 163,4	19.60 196,0	21.78 217,8	27.23 272,3	30 300	30 300	30 300	30 300	30 300	30 300
90	0.73 7,3		0.87 8,7	1.22 12,2	1.46 14,6	1.82 18,2	2.19 21,9	2.43 24,3	2.73 27,3	3.28 32,8	3.94 39,4	4.37 43,7	4.92 49,2	5.90 59,0	7.09 70,9	7.87 78,7	9.84 98,4	11.81 118,1	13.29 132,9	15.94 159,4	17.71 177,1	21.26 212,6	26.57 265,7	30 300	30 300

#### ● 단상 200V/240V

단위 = 상단 : N·m / 하단 : kgf·cm

Model Motor/Gearhead	Ratio Speed(rpm)	3	3,6	5	6	7,5	9	10	12,5	15	18	20	25	30	36	40	50	60	75	90	100	120	150	180	200	
		K9I□120F□-SU K9P□BU, BUF	1200	200V/220V/230V 240V/50HZ	2.02 20,2	2.42 24,2	3.36 33,6	4.03 40,3	5.04 50,4	6.05 60,5	6.72 67,2	7.56 75,6	9.08 90,8	10.89 108,9	12.10 121,0	13.61 136,1	16.34 163,4	19.60 196,0	21.78 217,8	27.23 272,3	30 300	30 300	30 300	30 300	30 300	30 300
200V/220V 230V/60HZ	1.94 19,4			2.33 23,3	3.24 32,4	3.89 38,9	4.86 48,6	5.83 58,3	6.48 64,8	7.29 72,9	8.75 87,5	10.50 105,0	11.66 116,6	13.12 131,2	15.75 157,5	18.90 189,0	21.00 210,0	26.24 262,4	30 300	30 300	30 300	30 300	30 300	30 300	30 300	30 300
90	200V/220V/230V 240V/50HZ		0.68 6,8	0.82 8,2	1.13 11,3	1.36 13,6	1.70 17,0	2.04 20,4	2.27 22,7	2.55 25,5	3.06 30,6	3.67 36,7	4.08 40,8	4.59 45,9	5.51 55,1	6.61 66,1	7.35 73,5	9.19 91,9	11.02 110,2	12.40 124,0	14.88 148,8	16.53 165,3	19.84 198,4	24.80 248,0	29.76 297,6	30 300
	200V/220V 230V/60HZ		0.73 7,3	0.87 8,7	1.22 12,2	1.46 14,6	1.82 18,2	2.19 21,9	2.43 24,3	2.73 27,3	3.28 32,8	3.94 39,4	4.37 43,7	4.92 49,2	5.90 59,0	7.09 70,9	7.87 78,7	9.84 98,4	11.81 118,1	13.29 132,9	15.94 159,4	17.71 177,1	21.26 212,6	26.57 265,7	30 300	30 300

- \* GEARHEAD-DECIMAL GEARHEAD는 별매입니다.
- \* GEARHEAD의 품명중 □에는 감속비가 들어갑니다.
- \*  색이 MOTOR와 같은 방향, 그 외에는 반대 방향입니다.
- \* 표의 감속비보다 더 감속하고자 할 경우는 GEARHEAD와 MOTOR 사이에 감속비 10의 DECIMAL GEARHEAD를 설치할 수 있습니다. 이 경우의 허용 TORQUE는 30 N·m / 300 kgf·cm 입니다.
- \* 회전수는 MOTOR의 동기 회전수 (50 Hz : 1500 rpm, 60 Hz : 1800 rpm)를 기준으로 하여 감속비로 나누어서 계산하였습니다. 실제의 회전수는 부하의 크기에 따라서 표시된 수치보다 2~20% 적습니다.

### CONNECTION DIAGRAMS

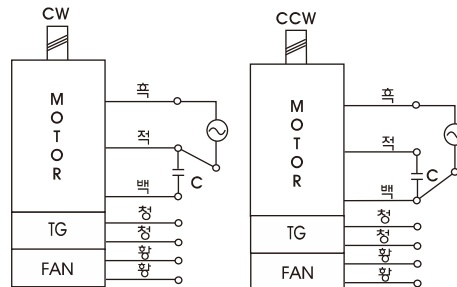

회전방향은 출력축에서 볼 경우

## GEARHEAD

### DIMENSIONS

K9P□B



K9P□BF, BUF

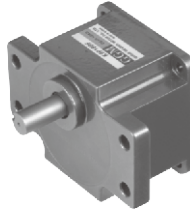

K9P□BU

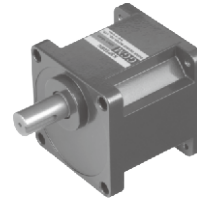

### DECIMAL GEARHEAD

K9P10BX

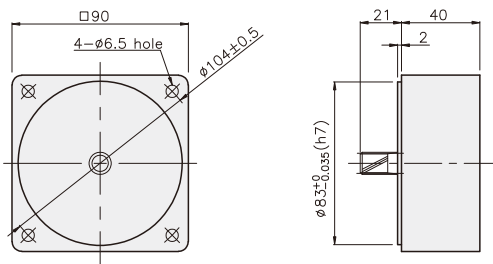

### KEY SPEC

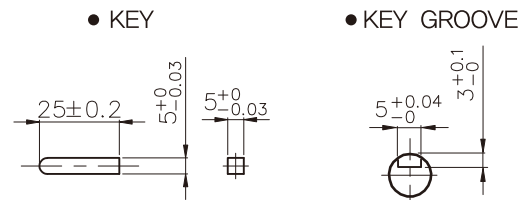

### GEARHEAD

K9P□B

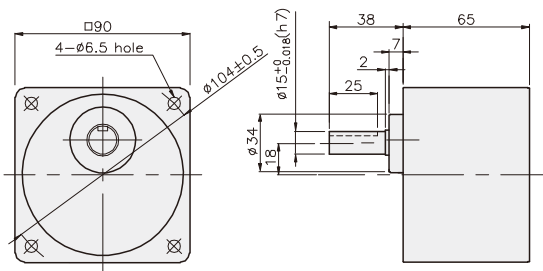

K9P□BF

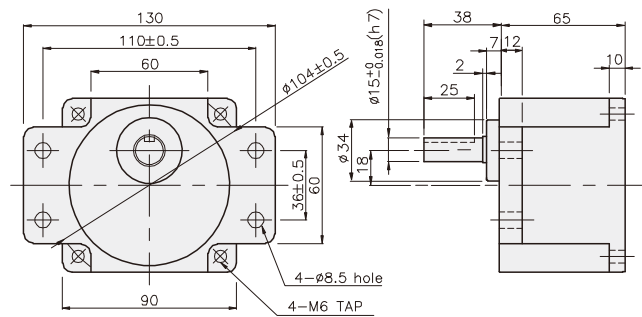

K9P□BU

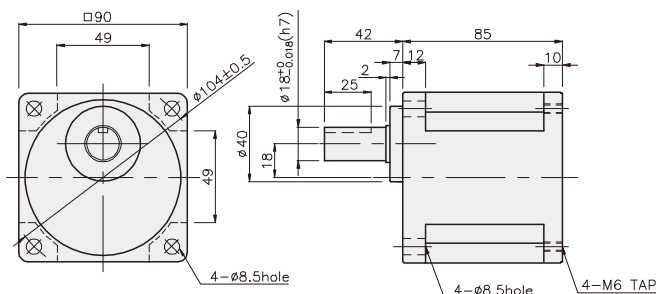

K9P□BUF

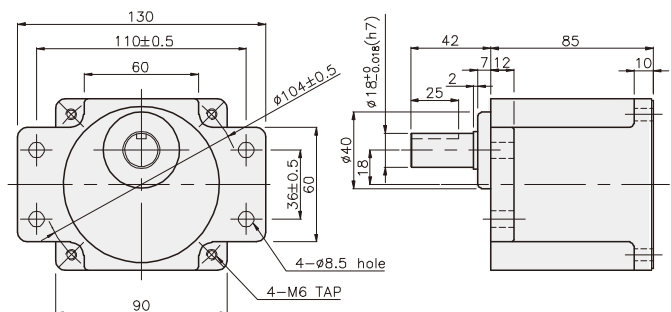

## GEARHEAD

### DIMENSIONS

K9IP120F□-SU + K9P□B



K9IP120F□-SU + K9P□BF, BUF

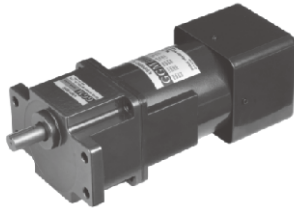

K9IP120F□-SU + K9P□BU

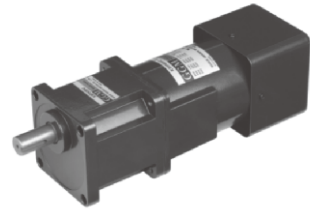

K9IP120F□-SU + K9P□B

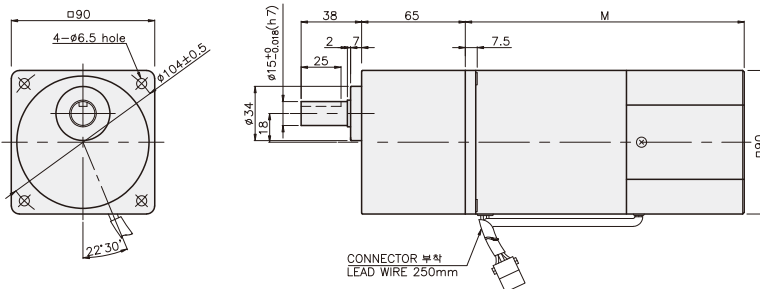

K9IP120F□-SU + K9P□BF

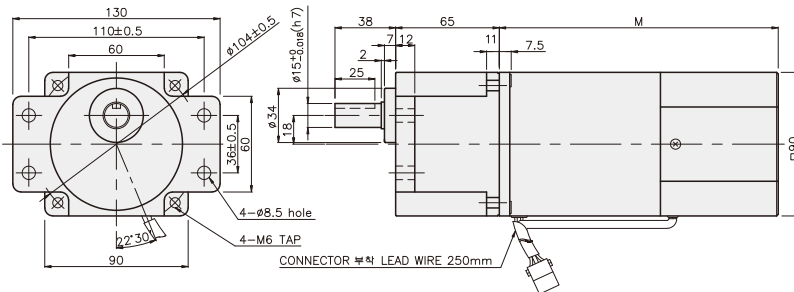

K9IP120F□-SU + K9P□BU

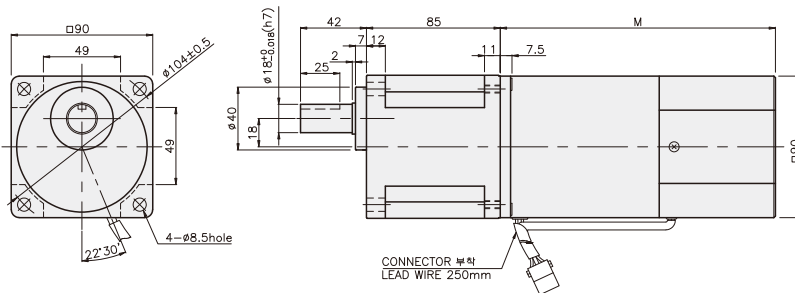

K9IP120F□-SU + K9P□BUF

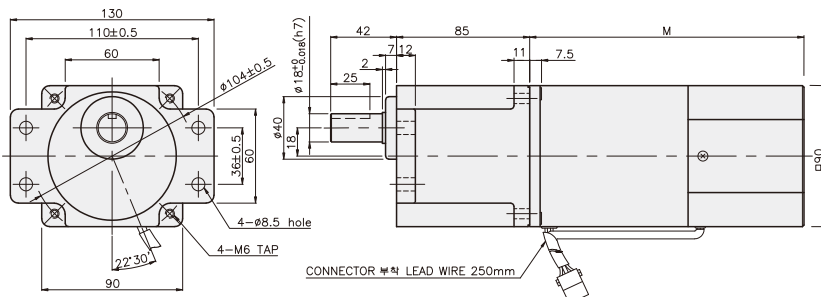

#### 무게

PART	WEIGHT(kg)
MOTOR	3.54
DECIMAL GEARHEAD	0.62

#### 치수도표

품번	M	적용기종
01	155	50Hz
02	135	60Hz

#### 치수도표

품번	적용기종	취부 BOLT
01	K9P3~200B	M6 P1.0 X 95
02	K9P10BX	M6 P1.0 X 140

#### 무게

PART	WEIGHT(kg)
K9P3~10B	1.22
K9P12.5~20B	1.32
K9P25~60B	1.42
K9P75~200B	1.45

#### 치수도표

품번	적용기종	취부 BOLT
01	K9P3~200BF	M6 P1.0 X 20
02	K9P10BX	M6 P1.0 X 65

#### 무게

PART	WEIGHT(kg)
K9P3~10BF	1.22
K9P12.5~20BF	1.30
K9P25~60BF	1.42
K9P75~200BF	1.44

#### 치수도표

품번	적용기종	취부 BOLT
01	K9P3~200BU	M6 P1.0 X 20
02	K9P10BX	M6 P1.0 X 65

#### 무게

PART	WEIGHT(kg)
K9P3~10BU	1.44
K9P12.5~20BU	1.55
K9P25~60BU	1.69
K9P75~200BU	1.74

#### 치수도표

품번	적용기종	취부 BOLT
01	K9P3~200BUF	M6 P1.0 X 20
02	K9P10BX	M6 P1.0 X 65

#### 무게

PART	WEIGHT(kg)
K9P3~10BUF	1.50
K9P12.5~20BUF	1.62
K9P25~60BUF	1.76
K9P75~200BUF	1.82