

REVERSIBLE MOTOR

40W

□80mm

LEAD WIRE TYPE

K8R□40F□



SPECIFICATIONS

40W 30分正格, 4极

Model	Out Put (W)	Voltage (V)	Frequency (Hz)	Current (A)	Start T. (N·m/kgf·cm)	Rated T. (N·m/kgf·cm)	Speed (rpm)	Condenser (μF)
K8R□40FC	单项	40	220	50	0.27	0.300	1300	3
					2.78	3.00		
				60	0.27	0.245	1600	
					2.78	2.45		
			230	50	0.31	0.300	1300	
					3.18	3.00		
				60	0.30	0.245	1600	
					3.10	2.45		

* □ : 电机轴形状 (S : STRAIGHT, G : PINION)

DIMENSIONS & CONNECTION DIAGRAMS

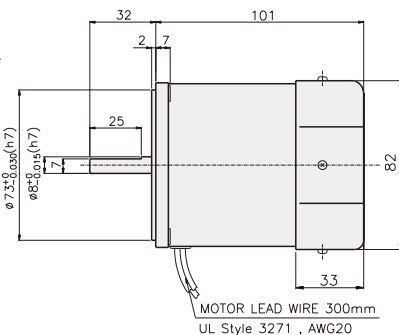
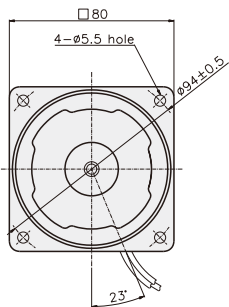

单项电机

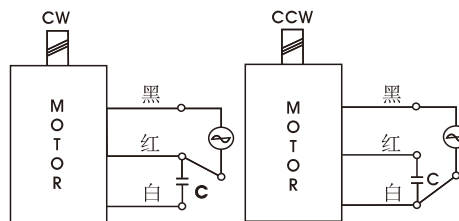

旋转方向由出力轴侧看时

3项电机

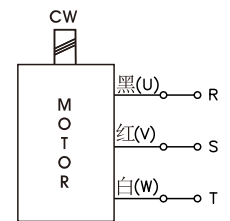

CCW是U, V, W 中2线交换连接

GEARHEAD

DIMENSIONS

K8G□B(C)



K8RG40F□ + K8G□B(C)



DECIMAL GEARHEAD
K8G10BX

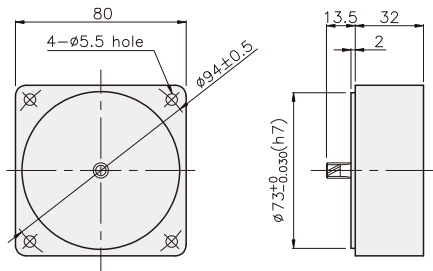

GEARHEAD
K8G□B(C)

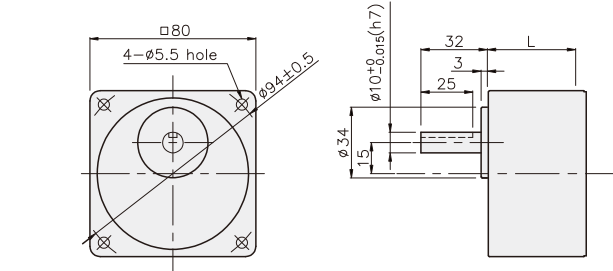

KEY SPEC

● KEY

● KEY GROOVE

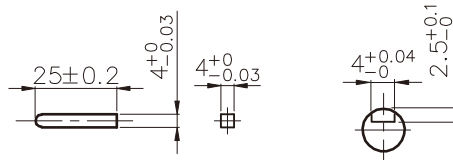

K8RP40F□ + K8G□B(C)

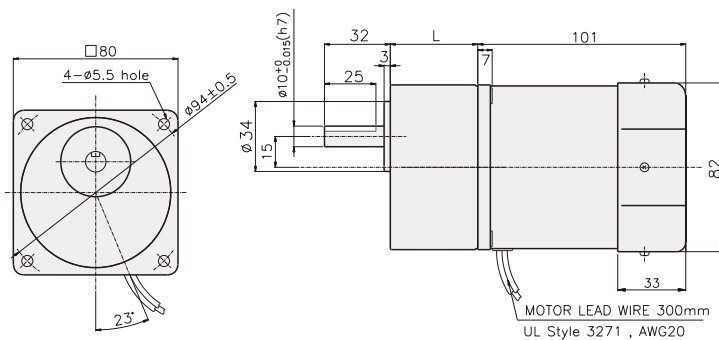

尺寸表

编号	L	应用型号	安装螺丝
01	32	K8G3~18B(C,M)	M5 P0.8 X 50
02	42.5	K8G20~250B(C,M)	M5 P0.8 X 65

重量

PART	WEIGHT(kg)	
MOTOR	1.70	
DECIMAL GEARHEAD	0.46	
GEAR HEAD	K8G3~18B(C)	0.51
	K8G20~40B(C)	0.64
	K8G50~250B(C)	0.70